



9410L

Less than 3lbs + 2207 lumens = brightest & lightest in its class
At less than 3 pounds and 2207 lumens, the new 9410L LED Lantern packs the power without the weight. Four LEDs, powered by the latest generation Lithium-Ion batteries illuminate a distance of 495 yards (453 meters). And it's loaded with innovative technology and features you have come to expect from Peli. The 9410L LED Lantern is one of the most compact, high output lanterns on the market.

- Built Peli tough
- Handy push button on/off switch
- High/Low/Flashing Modes
- Super bright LED beam
- Carrying Strap included



DIMENSIONS

Length	8.75" (22.2 cm)
---------------	-----------------

MATERIALS

Body	ABS
O-Ring	EPDM
Lens	Polycarbonate (PC)
Shroud	EXL

COLOURS

 Black	 High Visibility Yellow
---	--

LIGHT SPECS

Lamp Type	LED
------------------	-----

POWER

Battery Size	18650
Battery Type	Lithium-Ion
Battery Quantity	6
Batteries Included	yes
Rechargeable	yes
Charge Time	8 hrs
Battery Level Indicator	RGB LED
Volts	7.2v

WEIGHT

Weight With Batteries	44.7 oz (1267 gr)
Weight Without Batteries	0.0 oz (0 gr)

SWITCH







Switch Type	Push Button
--------------------	-------------

Light Modes

High / Low / Flashing

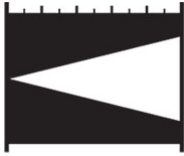
OTHER

Minimum Pack 1
Package Code B

FL1 STANDARD	HIGH	LOW
	2207 LUMENS	463 LUMENS
	3h 15mins	11h 0mins
	453m	207m
	51304cd	10710cd
	1m	
	IPX4	

ACCESSORIES



8056F
12v Plug-in for Fast Charger



9419L
Replacement Battery



9416L
Deck/Dash Charger Base Unit



6061F
Direct Wiring Rig for Fast
Charger

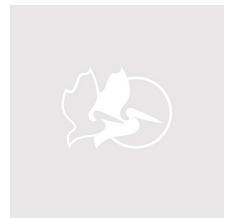

6058H
220V Transformer (UK)

Peli

c/ Provença, 388, Planta 7 • Barcelona, Spain 08025 • Phone: +34 934 674 999
info@peli.com • www.peli.com

Document created on 05-04-26